

# Installation and Maintenance Instruction Manual

## GOLD SERIES TRANSMITTERS



In the following configuration:

- PG55 Process pressure and level transmitter GOLD SERIES
- CG55 Cleanline pressure and level transmitter GOLD SERIES



**PG55**



**CG55**

**Table of contents:**

1	General remarks.....	4
1.1	Purpose of this Manual.....	4
1.2	Symbols.....	4
1.3	Limits of liability.....	4
1.4	Copyright.....	4
1.5	Warranty.....	4
1.6	Precautions and warnings.....	4
1.7	Manufacturer's address, customer services.....	5
2	Safety.....	5
2.1	General sources of hazards.....	5
2.2	Use in accordance with intended purpose.....	5
2.3	Operator's responsibility.....	5
2.4	Staff qualifications (target group assessment).....	5
2.5	Signs/Safety markings.....	6
2.6	Environmental protection.....	6
3	Certificates/ details.....	6
3.1	CE / EMC – Rules.....	6
3.2	Traceability year of manufacturing.....	6
3.3	Software revisions.....	6
4	Technical data.....	6
4.1	Specifications.....	6
4.2	External Load.....	7
5	Labeling.....	7
6	Construction and function.....	8
6.1	Process transmitter GOLD SERIES PG55.....	8
6.2	Cleanline transmitter GOLD SERIES CG55.....	8
6.3	Barometric reference.....	9
6.4	Accessories.....	9
7	Transport.....	9
7.1	Safety.....	9
7.2	Transport inspection.....	9
7.3	Storage.....	9
8	Assembly/Installation.....	9
8.1	Installing Weld-On Nipple.....	9
8.2	Installing Process Transmitter GOLD SERIES PG55 (with weld-on nipple).....	10
8.3	Installing Cleanline Transmitter GOLD SERIES CG55 (with weld-on nipple).....	10
8.4	Mounting Position.....	10
8.5	Mounting Position Effect (PG55 and CG55).....	10
8.6	Calibration.....	10
8.7	Wiring.....	10
8.8	Subsequent relocation of the transmitter (by the customer).....	11
8.9	Digital local indicator.....	11
9	Reading on the display.....	11

10	Functions of Push Buttons .....	12
11	Programming points(P101-P114) .....	12
12	Explanation of Programming points P101 to P114 .....	13
12.1	P101 Zero Adjustment (4 mA) .....	13
12.2	P102 Span Adjustment (20 mA) Without Test Pressure .....	13
12.3	P103 Cancel Mounting Position Effect .....	14
12.4	P104 Adjustment pressure unit on display (See Conversion table) .....	14
12.5	P105 Reverse Output (20 - 4 mA) .....	15
12.6	P106 Adjustment Damping (0 - 25 sec).....	15
12.7	P107 Indication of sensor temperature (read out on display) .....	15
12.8	P108 Temperature in °C or °F .....	15
12.9	P109 Read out on display .....	15
12.10	P110 Simulation of current (4-20 mA) .....	15
12.11	P111 Linearization .....	16
12.12	P112 Specific Density.....	18
12.13	P113 Write Protection.....	18
12.14	P114 Response Time from Push Buttons .....	18
12.15	P115 Service Menu .....	18
12.16	P116 Service Menu .....	18
13	Programming the GOLD SERIES .....	19
13.1	Programming with the hand held terminal .....	19
13.2	Programming with DTM .....	19
13.3	Programming with PDM.....	19
14	Servicing .....	19
14.1	Safety.....	19
14.2	Check on function, and recalibration .....	20
14.3	Cleaning and maintenance.....	20
15	Faults .....	20
15.1	Safety.....	20
15.2	Conduct in the event of faults .....	20
15.3	Fault table .....	20
15.4	Conduct following fault rectification .....	20
16	Removal, disposal.....	20
16.1	Safety.....	20
16.2	Removal.....	20
16.3	Disposal .....	20
17	Appendix .....	21
17.1	Data sheet for GOLD SERIES PG55 and CG55.....	21
17.2	Declaration of conformity model PG55 and CG55 .....	22

# 1 General remarks

## 1.1 Purpose of this Manual

This Operating Manual contains fundamental and essential advice to be followed for the installation, operation and servicing of the device. It must be read without fail before assembly and start-up of the device by the fitter, the operator and the specialist personnel responsible for the device. This Operating Manual must be available at the point of use at all times.

The following sections about general safety information and also the following specific advice regarding the intended purposes (Section 2), and through to disposal (Section 16) contain important safety information which, if not followed, may result in risks for people and animals, or to property and buildings.

## 1.2 Symbols



### Warning!

This indicates a possibly hazardous situation where failing to follow advice may result in risks to people, animals, the environment and buildings.



### Information!

This emphasizes key information for efficient, fault-free operation.

## 1.3 Limits of liability

Failure to respect this safety information, the envisaged uses or the limit values relating to use indicated in the technical data for the device may result in risk or to injury to people, the environment or the plant.

Claims for compensation for damage against the device supplier are excluded in such an eventuality.

## 1.4 Copyright

This Operating Manual may only be copied and passed on as a complete document with the special permission of the publisher.

## 1.5 Warranty

For the product described here, we offer a warranty pursuant to Section 6 Guarantee in Respect of Defects in our *General Terms and Conditions* of Delivery and Payment.

## 1.6 Precautions and warnings

- Check if the specifications of the transmitter meet the needs of the process conditions
- When the GOLD SERIES PG55 or CG55 is used as a level transmitter, be aware of the place where the transmitter is mounted. Here are some suggestions:
  1. DO NOT mount a level transmitter in- or near filling or discharging pipes.
  2. In case of automatic cleaning systems or hand cleaning: never point the water jets on the diaphragm, take necessary steps to avoid this. Guarantee will not be granted.
- When the GOLD SERIES PG55 or CG55 is used as a pressure transmitter, be aware of the following points:
  1. Rapid closing valves in combination with high flow velocity will cause water hammer(spikes) and can destroy the transmitter. DO NOT mount a transmitter near such valves, always a few pipe bends away up or down stream (avoid suction).
  2. Install a pressure transmitter a few pipe bends away from pumps, as well on the suction or pressure side of the pump
- WELDING INFORMATION: When using the GOLD SERIES with weld on nipple, the welding information in Section 8 must be followed exactly. This is very important to prevent distortion of the weld-on nipples. It also prevents the screw thread from the Cleanline transmitter CG55 (M56 x 1.25) from being deformed.
- The diaphragm of the transmitter is protected with a special protection cap. Protect the diaphragm until installation takes place, to prevent damaging of the diaphragm.
- As soon as the wiring is brought inside through the cable gland and connected to the terminal board, make sure the cable gland is tightly fixed, so that moisture cannot enter into the electronic housing.
- Avoid high pressure water-jets pointed at the venting.

- If the ambient conditions are very wet, we advise to use a venting through the cable. A special vented cable can be delivered on request. (The normal venting will be removed)
- The covers must be fully engaged, so that moisture cannot ingress into the electronic housing. The covers must only be capable of being released or removed with the aid of a tool.

## 1.7 Manufacturer's address, customer services

<b>Ashcroft Instruments GmbH</b>	Tel.: +49 (0) 2401/808-888
Max-Planck-Strasse 1	Fax.: +49 (0) 2401/808-999
D-52499 Baesweiler. Germany	E-mail: <a href="mailto:customer.service@ashcroft.com">customer.service@ashcroft.com</a>
	Web: <a href="http://www.ashcroft.eu">www.ashcroft.eu</a>

## 2 Safety

### 2.1 General sources of hazards

Pressure transmitters are pressurized parts where failure can result in hazardous situations. The selection of pressure transmitter should be made in accordance with the applicable national and international standards.

### 2.2 Use in accordance with intended purpose

The devices are only to be used for the intended purpose as described by the manufacturer.

The GOLD SERIES transmitters are solid-state pressure- and level transmitters based upon a bridge resistive silicon sensor, with a very high burst pressure. Pressure of the medium applied on a sensor element, creates a very small deflection of the silicon substrate and bridge network. The resulting strain in the silicon resistors causes a change in the bridge resistance that is proportional to the pressure applied. The transmitter electronics detects this change in bridge resistance and converts it into 4-20 mA. The amplifier system is based on a single Integrated Circuit, which ensures a perfect linearity in the 4-20 mA output.

The devices are used for pressure measurements in process or sanitary applications. For each use scenario, the corresponding set-up regulations must be respected. If used in explosion risk areas, the following conditions are to be respected for the individual finishes.

### 2.3 Operator's responsibility

Safety instructions for proper operation of the device must be respected. They are to be provided by the operator for use by the respective personnel for installation, servicing, inspection and operation. Risks from electrical energy and from the released energy of the medium, from escaping media and from improper connection of the device must be eliminated. The details for this are to be found in the corresponding applicable set of regulations, such as DIN EN, UVV (accident prevention regulations) and in sector-specific instances of use (DVWG, Ex-. GL, etc.) the VDE guidelines and the regulations supplied by local utilities companies.

The device must be taken out of service and secured against inadvertently being restarted, if the presumption is that risk-free operation is no longer possible (see Section 15: Faults).



Conversion works or other technical alterations to the device by the customer will violate the approval for hazardous area and are not permitted. This also applies to installation of spare parts. Possible conversions or alterations may only be carried out by the manufacturer.

The operational safety of the device is only guaranteed where it is used for its intended purpose. The specification of the device must be adapted to the medium used in the plant. The limit values indicated in the technical data must not be exceeded.

The safety information detailed in this Operating Manual, existing national regulations for accident prevention, and the operator's internal regulations regarding working, operations and safety must be respected.

The operator is responsible for all specified servicing, inspection and installation works being carried out by authorized and qualified specialists.

### 2.4 Staff qualifications (target group assessment)

The device may only be installed and started up by specialist staff who are familiar with installation, start-up and operation of the product.

Specialist staff are people who are able to assess the work assigned to them on the basis of their specialist training, their knowledge and experience and their knowledge of the relevant standards, and can identify possible risks.

For devices in explosion-protected configuration, these staff must have been trained or instructed in, or be authorized for, working on explosion-protected devices in potentially explosive plants.

## 2.5 Signs/Safety markings

The pressure transmitter and its surrounding packaging carry markings. These markings show the article number, measurement range and manufacturer. The pressure transmitter can be provided with additional signs and safety markings advising on special conditions:

- Advice on the filling liquid
- Advice on calibration
- Safety advice for flush diaphragm

## 2.6 Environmental protection

This device contains a small amount of silicone oil or a foodgrade oil(Neobee M20). The provisions set out in the REACH regulation on production and use of chemicals are to be respected, and the relevant safety data sheets from the manufacturers of the chemicals are available on our website for download.

# 3 Certificates/ details

## 3.1 CE / EMC – Rules

All GOLD SERIES transmitters are manufactured in accordance with the RFI / EMC directives and comply with the CE standard. All transmitters are fitted with RFI filters, which provide optimum, trouble-free operation. Our products are in conformity with EMC-Directive 2014/30/EU based on test results using harmonized standards.

## 3.2 Traceability year of manufacturing

The year of manufacturing of the transmitter can be traced as follows: take the first two numbers from the serial number that is engraved in the transmitter and add 1970 to it.

For example: if the serial number is 4309036. The year of manufacturing is 1970 + 43 = 2013.

## 3.3 Software revisions

Due to the improvements on the GOLD SERIES, there are several software versions (revisions). For this reason it is possible the transmitter you are working with does not support some options, which are discussed in this manual. This instruction is applicable from software revision V9.17. After powering up, the transmitter will show the revision number on the display.

# 4 Technical data

## 4.1 Specifications

Manufacturer	Ashcroft Instruments GmbH			
Instrument	GOLD SERIES PG55/CG55			
Output	4-20 mA Optional: HART® Protocol			
Power Supply	<b>Standard :</b> 12 – 36 Vdc <b>HART® :</b> 17 – 36 Vdc (Standard) min. 250 Ω			
Accuracy	0,1% of adjusted span			
Ranges <sup>1</sup>	<b>Code</b>	<b>Adjustable span ranges</b>		<b>Max. overpressure</b>
PG55	P4BR	0-0,1 bar	0-0,4 bar	6,4 bar
	1P2BR	0-0,3 bar	0-1,2 bar	10,5 bar
	10BR	0-1 bar	0-10 bar	30 bar
	30BR	0-5 bar	0-30 bar	100 bar
	100BR	0-20 bar	0-100 bar	200 bar
CG55	P4BR	0-0,04 bar	0-0,4 bar	6,4 bar
	1P2BR	0-0,1 bar	0-1,2 bar	10,5 bar

		10BR	0-1 bar	0-10 bar	30 bar
		30BR	0-5 bar	0-30 bar	100 bar
		100BR	0-20 bar	0-100 bar	200 bar
	CG55	<sup>2</sup>	High pressure		
Process Temperature <sup>3</sup>	PG55	-20 °C to +80 °C (-4 °F to 176 °F)			
	CG55	-20 °C to +100 °C (-4 °F to 212 °F)			
Temperature effect	0,015% / K				
Ambient Temperature	-20°C to 70°C (-4 °F to 158 °F)				
Damping	0,0 sec. till 25 sec. Standard damping: 0,0 sec.				
Protection grade	IP66				
Material	Housing	AISI 304 (Optional AISI 316)			
	"wet" parts	AISI 316 L (Other materials on request)			

1. For vacuum applications and compound ranges in combination with higher process temperatures a special oil filling must be applied. Contact Ashcroft Instruments for information.
2. For pressures higher than 100 bar, Contact Ashcroft Instruments for information.
3. For higher temperatures use other kind of pressure transmitters. Contact Ashcroft Instruments for information.

## 4.2 External Load

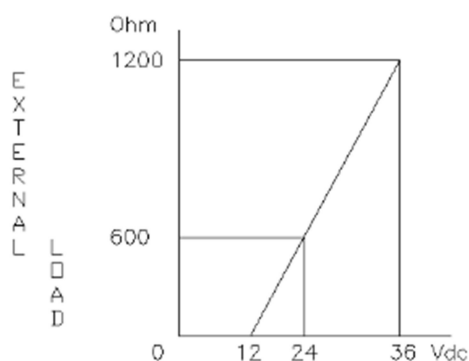

The minimum power supply is based on the total circuit resistance. The maximum permissible load (Ri max.) in case of 24 Vdc is 600 Ω (Ohm).

By increasing the power supply, the external load can be increased to 1200 Ohm / 36 Vdc. (see figure left).

$$Ri \text{ max.} = \frac{\text{Power Supply} - 12 \text{ Vdc}}{20 \text{ mA}}$$



With a loop resistance of 250 Ω a power supply of at least 17 Vdc must be used.

## 5 Labeling

The label with the serial number and type designation is located on the outside of the housing. The materials identifier is encoded in the type designation.

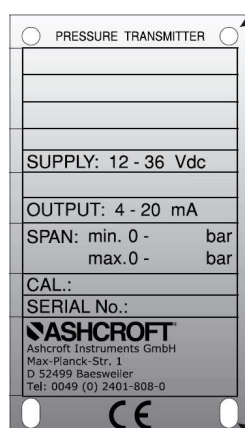

## 6 Construction and function

The GOLD SERIES transmitters are solid-state pressure- and level transmitters based upon a bridge resistive silicon sensor, with a very high burst pressure. The sensor element is mounted in a stainless steel foot. A very strong stainless steel flush diaphragm protects the sensor from the process medium. Special oil fills the chamber surrounding the sensor and transfers pressure from the flush mounted diaphragm to the sensor.

Pressure on the sensor element creates a very small deflection of the silicon substrate and bridge network. The resulting strain in the silicon resistors causes a change in the bridge resistance that is proportional to the pressure applied. The transmitter electronics detects this change in bridge resistance and converts it into 4-20 mA. The amplifier system is based on a single Integrated Circuit, which ensures a perfect linearity in the 4-20 mA output.

Together with the flush diaphragm technology the long term stability is perfect.

### 6.1 Process transmitter GOLD SERIES PG55

The PG55 are specially designed for the pulp- and paper or similar industries, where clogging is a problem. The very compact construction of the PG55 permits flush installation with the tank- or pipe wall. Standard the wetted parts are made of St.St. 316, a lot of other materials are available. All transmitters are fully temperature compensated, which means that various process temperatures have nearly no effect on the accuracy of the output signal. When a failure occurs, the transmitter is repairable. However, for optimum accuracy the transmitter has to be send back to the factory.

**DIMENSIONAL DRAWING PG55**

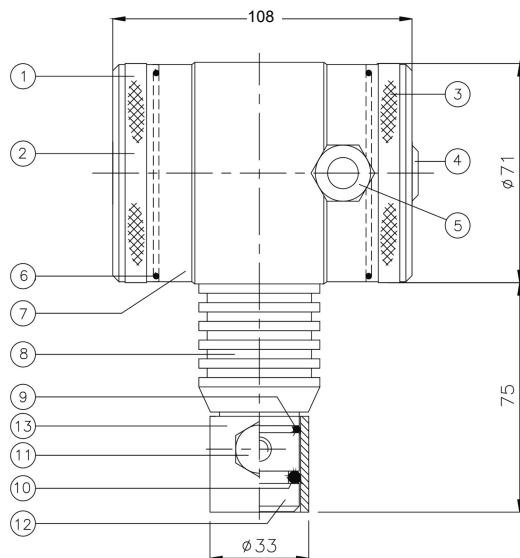

**PARTS DESCRIPTION**

**MATERIAL**

- |     |                                    |              |
|-----|------------------------------------|--------------|
| 1.  | Cover                              | St.St. 304   |
| 2.  | Pushbutton + Display               |              |
| 3.  | Cover with venting                 | St.St. 304   |
| 4.  | Venting                            | PA           |
| 5.  | PG9 Cable Gland                    |              |
| 6.  | O-ring (2 pcs)                     | EPDM         |
| 7.  | Electronics housing                | St.St. 304   |
| 8.  | Foot with cooling fins             | St.St. 304   |
| 9.  | O-ring                             | Viton        |
| 10. | O-ring                             | Viton        |
| 11. | M8 bolt                            | St.St. 316   |
| 12. | Diaphragm and ring                 | St.St. 316   |
| 13. | Weld-on nipple $\varnothing$ 33 mm | St.St. 316 L |

### 6.2 Cleanline transmitter GOLD SERIES CG55

The CG55 are specially designed with a flush mounted diaphragm so they fully meet the needs of the food, pharma and chemical industries. Standard the wetted parts are made of St.St. 316, other materials are available, like Hastelloy C. Various process connections can be delivered, such as Tri-Clamp (1,5", 2" and 3"), SMS (1,5" and 2"), dairy milk couplings (DN 25, 40 and 50), flanges (DIN and ANSI) and sanitary weld-on nipples ( $\varnothing$  48, 62 and 85 mm.)

**DIMENSIONAL DRAWING CG55**

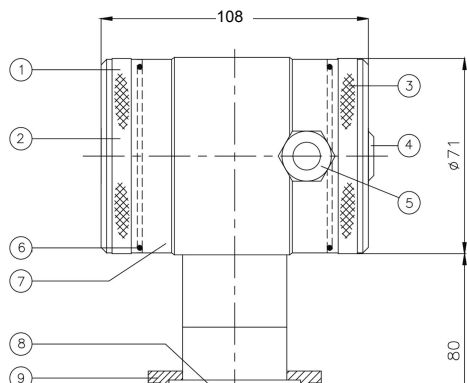

**PARTS DESCRIPTION**

**MATERIAL**

- |    |                      |            |
|----|----------------------|------------|
| 1. | Cover                | St.St. 304 |
| 2. | Pushbutton + Display |            |
| 3. | Cover with venting   | St.St. 304 |
| 4. | Venting              | PA         |
| 5. | PG9 Cable Gland      |            |
| 6. | O-ring (2 pcs)       | EPDM       |
| 7. | Electronics housing  | St.St. 304 |
| 8. | Foot                 | St.St. 316 |
| 9. | Lock ring            | St.St. 304 |



10.	Weld-on nipple	St.St. 316 L
11.	Packing	PTFE
12.	Diaphragm	St.St. 316 L

### 6.3 Barometric reference

The CG55 is in basic a so-called "relative transmitter" which means that barometric changes will not affect the zero (4 mA). The venting (4) is placed in the cover of the housing and is the barometric reference to atmospheric. The venting must be kept clean.

### 6.4 Accessories

Please contact the manufacturer regarding special tools and accessories.

## 7 Transport

### 7.1 Safety

The device should be protected against the effects of knocks and impacts. The device should only be transported in the packaging provided, to protect against damage. The device should only be transported in a clean condition (free of residues of measuring media).

### 7.2 Transport inspection

The delivery must be checked for completeness and damage during transport. In the event of damage during transport, the delivery must not be accepted, or only accepted subject to reservation of the scope of the damage being recorded and, if necessary, a complaint initiated.

### 7.3 Storage

The device must be stored in dry, clean conditions, within a temperature range of -20 to +70 °C, protected against direct exposure to sunlight and protected against impact damage.

## 8 Assembly/Installation

The diaphragm of the transmitter is protected with a special protection cap. Protect the diaphragm until installation takes place. \* DO NOT DAMAGE THE DIAPHRAGM. \*

### 8.1 Installing Weld-On Nipple

A certified welder should perform installation of the weld-on nipple. Weld with Argon, MIG or TIG. The smallest welding pin should be used.

1. Cut a hole in the process vessel/pipe to accept the weld-on nipple. The hole should produce a tight fit when coupled with the weld-on nipple.
2. Prepare the hole by beveling the edge to accept filler material.
3. Remove the weld-on nipple from the transmitter.
4. Remove the PTFE packing of the Cleanline transmitter GOLD SERIES CG55
5. **Remove the gasket and O-ring out of the weld-on nipple!**

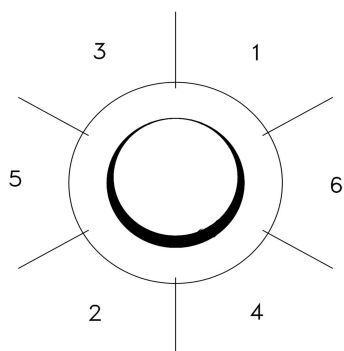

Improper installation may result in distortion of the weld-on nipple. Excessive heat will distort the weld-on nipple. Weld in sections as shown in the figure left. Allow adequate cooling between passes. **To reduce the chances of distortion to the weld-on nipple, use a mandrel.**

(PG55 Part.no. 1016)

(CG55 Part.no. 1019)

Determine (before welding) the position of the electronic housing, so that the cable entry and the venting are in the right position. After welding these positions are fixed.

6. Position the weld-on nipple in the vessel hole and tack six places. The weld sequence is shown in the figure above.

7. Weld the weld-on nipple in place using 0,03 to 0,045 in. (0,762 to 1,143 mm) stainless rod as filler material in the beveled area. Adjust amperage for penetration.
8. Remove the mandrel after the welding operation.

## 8.2 Installing Process Transmitter GOLD SERIES PG55 (with weld-on nipple)

1. After welding, clean up edges, and take care of the inside nipple wall.
2. Make sure the O-rings (9) and (10) are properly located. Improper installation at the O-ring can cause a process leak.
3. Apply silicone grease to the O-ring(9), diaphragm ring and the hole inside wall of the weld-on nipple, this prevents galvanic cell corrosion between transmitter and nipple inside.
4. Install the transmitter and fix it with the St.St. M8 bolt.

## 8.3 Installing Cleanline Transmitter GOLD SERIES CG55 (with weld-on nipple)

1. Make sure to correctly locate the packing within the weld-on nipple.
2. Improper installation of the packing can cause a process leak.
3. Position the transmitter into the weld-on nipple and begin engaging threads.  
The transmitter can be rotated prior to seating enabling the user to optimize access to calibration adjustments, cable entry, and local indicator.
4. Once the Lock ring (9) has been hand tightened, it must be tightened with an additional turn with adjustable pliers ( $\pm 1/8''$ ).

## 8.4 Mounting Position

When the transmitter is mounted horizontally, the cable gland must be pointed downwards.

## 8.5 Mounting Position Effect (PG55 and CG55)

All transmitters are calibrated in vertical position.

If the transmitter is mounted in another position, there can be a little zero shift.

If the transmitter is mounted up, there is a zero shift (e.g. 4,02 mA instead of 4 mA). If the transmitter is mounted down, there is a zero shift (e.g. 3.98 mA instead of 4 mA). After installation of the transmitter the zero must be set to 4.00 mA with "P103" in the programming mode (see Section 12.3). This will not affect the span.

## 8.6 Calibration

All transmitters are fully calibrated at the factory, to customer specified range. If calibration is not specified, the transmitter will be calibrated at the maximum span.

## 8.7 Wiring

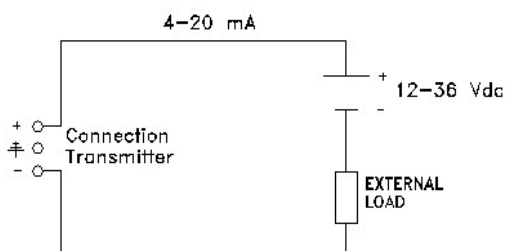

Under the cover (Part No.3) you will find the terminal board.

The push buttons "Zero", "Span" and "Prog" are under the other cover (Part No.1). External loads must be placed in the negative side of the 2-wire loop.

The figure left shows the wiring connection of the transmitter. The 2-wires must be connected to 3 (-) and 4 (+) of the terminal board.

The screw terminal tightening torque range needs to be: minimum 1.0 Nm (8.85 in-lb); max. 1,2 Nm (10.62 in-lb).

Remove approx. 5 cm (2 in) of the cable mantle, strip approx. 1 cm (0.4 in) of insulation from the ends of the individual wires. When using stranded cable apply the correct end sleeves for the wires and make sure these are connected properly underneath the screw terminals.

The field wire conductor cross-section needs to be: minimum 0,2 mm<sup>2</sup> (24 AWG) and maximum 1,5 mm<sup>2</sup> (16 AWG).

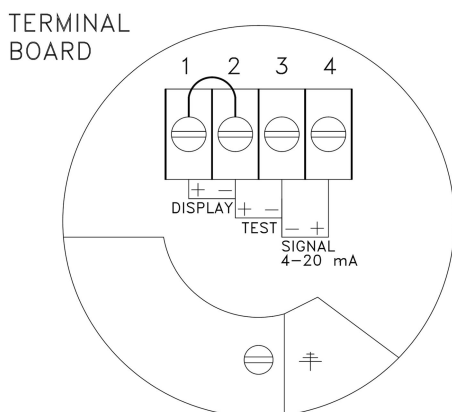

**The transmitter must always be connected to earth**  
 The transmitter must be connected with standard two-wire shielded cable. **Do NOT** run signal wiring in open trays with power wiring, or near “heavy” electrical equipment (E.g.: Frequency controller or heavy pumps). Shielding must always be connected at the side of the power supply. In case the process connection is already connected to ground (e.g. via the tank or pipe line) **Do not** connect the instrument to ground. **Please ensure that the instrument is not connected to ground twice to prevent an 'earth loop'**. In applications with synthetic process connections, the enclosure (internal or external) must be connected to ground.

## 8.8 Subsequent relocation of the transmitter (by the customer)



**Recommendation:** Do not remove the transmitter from one metering point and fit it in a different place, as there is a risk of the measuring media being mixed, with unforeseeable chemical reactions.

## 8.9 Digital local indicator

All transmitters from the GOLD SERIES are standard equipped with a digital display.

In the standard circumstances the covers are "closed". The three push buttons and the display are behind the cover.

As an option an "transparent" cover can be delivered to achieve the display can be used as a local display in the process. The full-scale point may be set to any value between 0000 and 9999 (4 digit). (Option: DG extra price).

## 9 Reading on the display

On the standard built-in display several values can be shown.

During the programming of the transmitter the display shows all the information that is needed.

When the transmitter is in the process the display gives all the information of the process pressure or temperature.

On the display the following units can be showed: mH<sub>2</sub>O, inH<sub>2</sub>O, bar and PSI (see also Programming points P104 and P109 in Section 12).

PROG	mH <sub>2</sub> O
ZERO	inH <sub>2</sub> O
—	bar
SPAN	psi

N.B.: The standard transmitter is supplied with two "closed" covers shielding the buttons and the display. As an option an "open" cover (IP 66) can be fitted. The display can then be used as a local process display. (Option: DG extra price). The full scale can be set between -9999 and 9999 (4 digit).

## 10 Functions of Push Buttons

The GOLD SERIES can be programmed easily by use of the 3 front panel pushbuttons (See picture right). The display can show engineering units of: mH<sub>2</sub>O, inH<sub>2</sub>O, bar and PSI.

The functions of the three pushbuttons will be explained below.

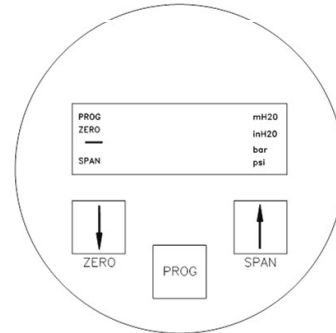

This button has 2 functions:

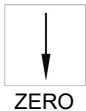

1. It can be directly used for adjusting the zero (zero / 4mA), with or without a test pressure. When the zero (4 mA) must be adjusted at 0 (atmospheric pressure), the button must be held until the word "ZERO" appears on the display. The transmitter is now set to 4 mA.
2. Also, this button must be used for stepping down in the programming menu or to decrease a value (-).

**Note: For canceling the mounting position effect you have to use P103.**

This button has 2 functions:



1. It can be directly used for adjusting the span (20 mA), when using a test pressure (air). When a test pressure (e.g. 2 bar) is supplied to the transmitter, the button must be held until the word "SPAN" appears on the display. The transmitter is adjusted at 20 mA now. The span can also be adjusted without test pressure (see P102).
2. Also, this button must be used for stepping up in the programming or to increase a value (+).

This button has 2 functions:



1. It is used to adjust the 14 Programming Points (P101 to P114). Push it once and P100 is displayed, use the [↑] (SPAN) to step to P101 etc.
  2. This button must also be used for confirming the adjustments (enter).
- For example if you want to change the adjustment in bars (P104), the following steps must be taken:

1. Push on [PROG] till "100" appears on the display.
2. Push on [SPAN] 4 times to go to point "P104" (adjustment pressure unit).
3. Push [PROG] to confirm this.
4. Push several times on [↑] (SPAN) to reach 3 (= bar). See also the conversion table Section 12.4  
1 = mWC, 3 = bar, 5 = PSI, 11 = inch WC
5. Confirm this by pushing once at [PROG].  
The transmitter is now adjusted to read in "bar".

## 11 Programming points(P101-P114)

The following points can be adjusted by means of the three push buttons.

For an explanation of these points see Section 12 of this manual.

To change one of these points you have to push on [PROG] until "100" appears on the display.

To go to from a lower program (P101) to a higher one (P102), push on button [↑] (SPAN).

To confirm the adjustments you always have to press on [PROG].

Programming points:	
P101	Zero adjustment (4 mA)
P102	Span adjustment (20 mA)
P103	Cancel mounting position effect
P104	Adjustment pressure unit (See Conversion table)
P105	4-20 mA (*) 20-4 mA (Reverse output)
P106	Adjustment damping (0 to 25 sec)

P107	Indication of process temp. (Read out on display)
P108	0 = °C (*) 1 = °F
P109	Read out on display: Curr (0) = current (4 - 20 mA) (*) Unit (1) = pressure unit (conversion table) PerC (2) = percentages TenP (3) = temperature Hect (4) = hectoliters CB n (5) = Cubic meters Ltr (6) = Liters
P110	Simulation of current
P111	Linearization 0 = no Linearization (*) 1 = cylindrical tank 2 = vertical tank with cone 3 = vertical tank with spherical cone
P112	Specific density
P113	Write Protection
P114	Response time from push buttons

\*) Standard adjustments ex works.

## 12 Explanation of Programming points P101 to P114

The following points can be adjusted by means of the three push buttons

### 12.1 P101 Zero Adjustment (4 mA)

The transmitter as standard is adjusted to 4.00 mA at atmospheric pressure.

It is also possible to adjust a zero-suppression or elevation.

For example: zero elevation of 1 mWK.

1. Push at [PROG] until "100" is shown on the display.
2. Push once at [↑] / SPAN till "101".
3. Confirm this by pushing [PROG].
4. Now the display will show 0.00 mH<sub>2</sub>O. Push at [↑] till 1.00 mH<sub>2</sub>O is on the display.
5. Confirm with [PROG].
6. The output of the transmitter will be lower than 4 mA. The output at atmospheric pressure will be for example 3.68 mA.

When a pressure of 1 mWC is applied on the diaphragm the output will be 4.00 mA.

The elevation can be canceled by pushing at [ZERO] till zero disappears out of the display. The transmitter is now adjusted at 4 mA at atmospheric pressure.

### 12.2 P102 Span Adjustment (20 mA) Without Test Pressure

Before adjusting the span take care the right pressure unit is selected.

(See also P104 and P109).

Example: Adjustment of the span at 0 - 2 bar.

First of all, the pressure unit must be adjusted at "bar". (See P104).

1. Push [PROG] till "100" is shown on the display.
2. Push twice at [↑] / SPAN until "102" is on the display.
3. Confirm this by pushing [PROG].
4. Push [SPAN] (+) or [ZERO] (-) to select the measuring range that is required.
5. Confirm by pushing [PROG].  
The transmitter is adjusted now.

**N.B.:** P102 is the adjustment of the total span.

When a "compound" range must be adjusted (for example -1 till +3 bar), a span of 4 bar must be programmed. At P101 (ZERO,4 mA), -1 bar must be adjusted. Now the transmitter is adjusted at: - 1 bar = 4 mA and +3 bar = 20 mA.

- If the process temperature at -1 bar is above 20 °C **another filling oil** must be applied inside the transmitter
- If the process temperature at -0,5 bar is above 60 °C **another filling oil** must be applied inside the transmitter

**N.B.:** It is not possible to show values larger than '9999' or smaller than '-9999' on the display. In this case the display will show: '----' For values larger than '9999' and smaller than '-9999'. As long as the display shows "- - - -", the value will not be saved by pressing "PROG"

### 12.3 P103 Cancel Mounting Position Effect

All transmitters are calibrated vertically. When a transmitter of the GOLD SERIES is installed horizontally, there will be a small "mounting effect" on the zero(4 mA). For example the transmitter shows 4.03 mA instead of 4.00 mA.

This can be easily canceled with P103. In P103 there are three options:

1. **ESC:**  
Nothing can be changed.  
Leave without doing anything. (confirm with PROG).
2. **RESET:**  
Use this option when you are not sure if P103/SET has been done in a proper way. (confirm with PROG). when using this option the original factory setting will be valid.
3. **SET:**  
Canceling mounting position effect.(confirm with PROG).  
When "SET" is selected the transmitter is automatically adjusted at 4.00 mA. The span will not be affected.

**CAUTION:** Do not apply pressure while executing "cancel mounting position effect"

**N.B.:** From software revision 2 the description above is valid. Transmitters working with software revision 1 will direct process cancel mounting position.

### 12.4 P104 Adjustment pressure unit on display (See Conversion table)

Several engineering units can be shown on the display by using a conversion factor.(See conversion table below). As standard the pressure unit of the transmitter is set to bar. Four engineering units can be used for displaying the applied pressure on the display (mH<sub>2</sub>O, inH<sub>2</sub>O, bar and PSI).

This will be explained with an example (e.g. bar):

1. Push at [PROG] till "100" is shown on the display.
2. Push 4 times at [↑], go to [P104].
3. Push at [PROG] to confirm this.
4. Push at [↑] and adjust at 3 (= bar).  
1 = mH<sub>2</sub>O (=mWC), 3 = bar, 5 = PSI, 11 = inch WC.
5. Confirm with [PROG].  
The transmitter will now read out in bars.

#### Conversion Table

104	CONVERSION FACTOR	DISPLAY	
1	1.000	mH <sub>2</sub> O (mWC)	*
2	1000	mmH <sub>2</sub> O (mm WC)	
3	0.09806	bar	*
4	98.0665	mbar	
5	1.4223	PSI	*
6	0.0967	Atm	
7	9.80665	KPa	
8	0.009807	MPa	
9	0.1	Kgf/cm <sup>2</sup>	
10	73.556	mm HG	
11	39.37	inH <sub>2</sub> O ("WC)	*
12	2.895906	"HG	

**N.B.:** To show one of the engineering units, P109 must be adjusted at 1(= pressure unit).

\*) *Pressure units that can be shown on the display.* When the value of the highest range is larger than 9999, "NA" will appear in the display (Not Applicable). Another unit must be chosen.

## 12.5 P105 Reverse Output (20 - 4 mA)

The transmitter as standard is adjusted to 4-20 mA.

Push on [PROG] and go to P105.

Push once at [↑] to change the output to 20-4 mA (Reverse output).

Push at [PROG] to confirm this.

Now the transmitter will give 20 mA at atmospheric pressure.

## 12.6 P106 Adjustment Damping (0 - 25 sec)

In P106 an electronic damping can be adjusted between 0 and 25 seconds.

This can be done with the push buttons [↑] (up) and [↓] (down).

Always confirm by pushing once at [PROG].

## 12.7 P107 Indication of sensor temperature (read out on display)

1. Push [PROG] until "100" is shown on the display.
2. Push 7 times at [↑], go to [P107].
3. Push [PROG] to confirm this. Now the process temperature appears on the display (Accuracy depending on sensor position).

This will remain on the display. To get the actual pressure back on the display you have to push again on P107 until the actual pressure appears on the display again

## 12.8 P108 Temperature in °C or °F

The temperature of the transmitter is standard adjusted at °C ("CELC"). When pushing at [↑] in P108, this will change into °F ("FAHR").

Always confirm by pushing once at [PROG].

## 12.9 P109 Read out on display

Curr (0) = current	(4 - 20 mA)
Unit (1) = pressure unit	(See conversion table)
PErC (2) = percentages	(0 - 100%)
TEnP (3) = temperature	(°C of °F) <i>Indication of process temperature, accuracy depending on sensor position.</i>
HECt (4) = hectoliter	(only in combination with P111)
Cb n (5) = Cubic meter	(only in combination with P111)
Ltr (6) = Liters	(only in combination with P111)
FREE (7) = Free adjustable scale	(only in combination with P111)

As standard the transmitter is delivered with read out in mA (0). To change this, follow the next steps:

1. Push [PROG] until "100" is shown on the display.
2. Push 9 times at [↑] / SPAN till "109" appears on the display.
3. Confirm with [PROG].
4. Push once at [↑].
5. Push [PROG] to confirm this.  
The transmitter will now read mH<sub>2</sub>O (mWC).  
The pressure unit can be changed with the conversion table in "P104".  
1 = mH<sub>2</sub>O (=mWK), 3 = bar, 5 = PSI, 11 = inch WK.

Also the read out can be 0 - 100%. In this case select "P109", option 2.

## 12.10 P110 Simulation of current (4-20 mA)

The transmitter can be used as a simulator of a current between 4 - 20 mA.

This can be done in P110 with the push buttons [↑] and [↓].

The user can perform a current simulation (Curr) or a pressure simulation (Unit).

### Current-simulation (Curr)

To perform a current-simulation follow the next steps:

1. Push [PROG] until "100" is shown on the display.
2. Push 10 times at [↑] / SPAN till "110" appears on the display.
3. Confirm with [PROG].
4. The display will readout 'Curr'
5. Confirm with [PROG].
6. The display shows '4.00'. Push [PROG] and the output changes to 4.00 mA.
7. By pushing [↑] / SPAN or [↓] / ZERO, you can change the value on the display. The output value will change as soon as the [↑] / SPAN or [↓] / ZERO button is released.

8. Pressing the [PROG]-button again will exit the simulation.

**Pressure-simulation (Unit)**

To perform a pressure-simulation follow the next steps:

1. Push [PROG] until "100" is shown on the display.
2. Push 10 times at [↑] / SPAN till "110" appears on the display.
3. Confirm with [PROG].
4. The display will readout 'Curr'
5. Press [↑] / SPAN once
6. The display will readout 'Unit'.
7. Confirm with [PROG].
8. The display shows a pressure value. Push [PROG] and the output changes to a mA-output corresponding with the range entered in menu P101 and P102.
9. By pushing [↑] / SPAN or [↓] / ZERO, you can change the value on the display. The output value will change as soon as the [↑] / SPAN OR [↓] / ZERO button is released.
10. Pressing the [PROG]-button again will exit the simulation.

**Note:**

- The values that can be entered using the pressure-simulation are related to the adjustments in menu P101 and P102. These values are also the minimum and maximum values.
- For HART-transmitters: this menu will not work when the device is operating in multi-drop mode.

**12.11 P111 Linearization**

0 = no Linearization

1 = cylindrical tank (horizontal)

2 = tank with bottom cone

3 = tank with spherical bottom

4 = Free adjustable scale (Linear)

As standard the transmitter is delivered without Linearization (= 0). However, for a horizontal tank or a tank with a bottom cone, a Linearization can be applied to achieve the current signal (mA) is equal to the level in the tank. All values must be programmed in meters.

**Linearization horizontal tank (Cylindrical)**

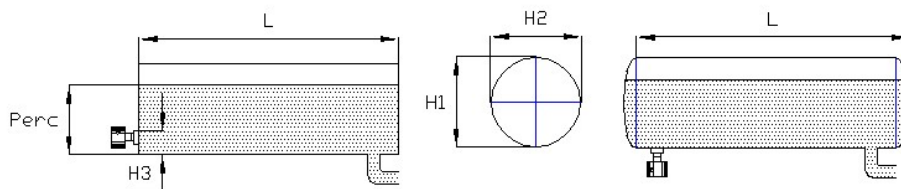

**Cylindrical horizontal tank**

**Cylindrical tank with cone-shaped ends**

1. Push [PROG] until "100" is shown on the display.
2. Push 11 x at [↑] / SPAN till "111" appears. (Confirm with [PROG])
3. Push [↑] once. (Confirm with [PROG])
4. Enter the height (H1) of the tank in meters. (Confirm with [PROG])
5. Enter the same height (H2) of the tank in meters. (Confirm with [PROG])
6. Enter the length (L) of the tank. For a "ball" or cone shaped tank, take the cylindrical length plus the length of 1 "ball" cone. (Confirm with [PROG])
7. Enter H3 in meters if the transmitter is installed like in the left picture. Enter 0m when the transmitter is installed like in the right picture.
8. Enter the percentage of the actual "full" level (for example 80%). (Confirm with [PROG]).



### Linearization horizontal tank (Elliptic)

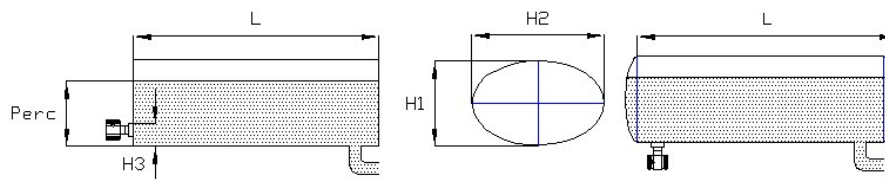

#### Cylindrical horizontal tank

#### Cylindrical tank with cone-shaped ends

1. Push [PROG] until "100" is shown on the display.
2. Push 11 x at [↑] / SPAN till "111" appears. (Confirm with [PROG])
3. Push [↑] once. (Confirm with [PROG])
4. Enter the height (H1) of the tank in meters. (Confirm with [PROG])
5. Enter the height (H2) of the tank in meters. (Confirm with [PROG])
6. Enter the length (L) of the tank. For a "ball" or cone shaped tank, take the cylindrical length plus the length of 1 "ball" cone. (Confirm with [PROG])
7. Enter H3 in meters if the transmitter is installed like in the left picture. Enter 0m when the transmitter is installed like in the right picture.
8. Enter the percentage of the actual "full" level (for example 80%). (Confirm with [PROG]).

**Note:** If the height (H) of the tank is 1 meter and the maximum level in the tank is 0,8 meter the percentage (point 8) must be set at 80%. The calibration at P102 must be adjusted at: 1 meter (if s.g. equals 1).

### Linearization vertical tank with cone

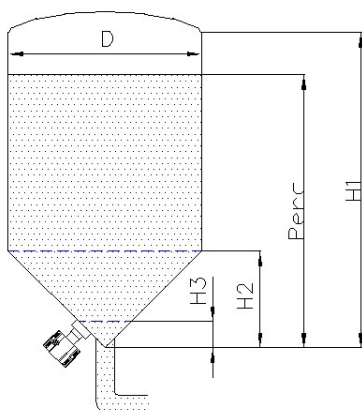

1. Push [PROG] till "100" appears on the display.
2. Push 11 times at [↑] till "111" appears. (Confirm with [PROG])
3. Push twice at [↑]. (Confirm with [PROG])
4. Enter height (H1) of the tank (= actual level).(Confirm with [PROG]).
5. Enter diameter (D) of tank. (Confirm with [PROG])
6. Enter height (H2) of cone. (Confirm with [PROG])
7. Enter the height (H3) from the bottom of the tank to the topside of the diaphragm (or weld-on nipple). (Confirm with [PROG]).
8. Enter the percentage of the actual "full" level (for example 80%).(Confirm with [PROG]).

### Linearization vertical tank with spherical cone (from software revision 3)

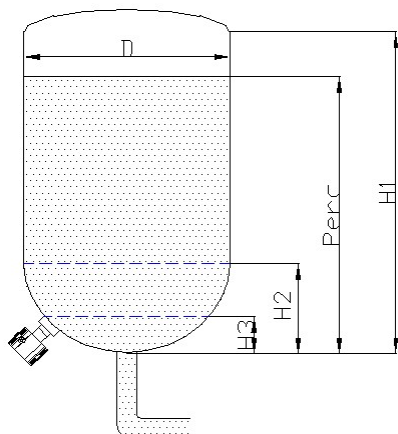

1. Push [PROG] till "100" appears on the display.
2. Push 11 times at [↑] till "111" appears. (Confirm with [PROG])
3. Push three times at [↑]. (Confirm with [PROG])
4. Enter height (H1) of the tank (= actual level).(Confirm with [PROG]).
5. Enter diameter (D) of tank. (Confirm with [PROG])
6. Enter height (H2) of cone. (Confirm with [PROG])
7. Enter the height (H3) from the bottom of the tank to the topside of the diaphragm (or weld-on nipple). (Confirm with [PROG]).
8. Enter the percentage of the actual "full" level (for example 80%).(Confirm with [PROG]).

**Note**

When the specific gravity of the fluid is unequal to 1 and you do not want to use option 4, you must take care of it by defining the **calibration** of the transmitter. Calibration (see P102) = Height of the level x Specific Gravity.

**Free adjustable scale**

1. Push [PROG] till "100" appears on the display.
2. Push 11 times at [↑] till "111" appears. Confirm with [PROG].
3. Navigate to FREE with the arrow [↑] buttons. (Confirm with [PROG])
4. The next step is entering the amount of digits of the reading. With the arrow [↑] buttons the decimal can be changed to left or right.
5. SET MIN appears on the display, and the minimum value can be set, by using the arrow [↑] buttons. Confirm with [PROG].
6. SET MAX appears on the display, and the maximum value can be set, by using the arrow [↑] buttons. Confirm with [PROG].
7. To display this configuration on the display navigate to P109. Choose FREE and confirm with [PROG].

**12.12 P112 Specific Density**

If the specific gravity of the medium differs from 1 kg/dm<sup>3</sup>, you can enter the real density of the medium in P112. When this option is used, in menu P102, the 'true' height of the tank must be entered.

**12.13 P113 Write Protection**

The GOLD SERIES with HART-Protocol can be protected for writing (Write Protection). This is possible for two kinds of writings:

- Changes via the Display ("Lo.Pr" = Local Protection).
- Changes via external HART configuration software by the **Hand-held terminal or the P.C.** ("Co.Pr." = Communication Protection).

As standard, the transmitter is set to no-write protection.

**Adjustment Local Protection**

1. Push [PROG] till "100" appears on the display.
2. Push [↑] / SPAN 13 times till "113" appears on the display.
3. Push [PROG] to confirm. ("Lo.Pr." appears on the display).
4. Push [↑]/[↓] for adjusting to "ON" or "OFF".
5. Push [PROG] to confirm.

**Adjustment Communication Protection**

1. Push [PROG] till "100" appears on the display.
2. Push [↑] / SPAN 13 times till "113" appears on the display.
3. Push [PROG] to confirm. ("Lo.Pr." appears on the display).
4. Push once more at [PROG]. ("Co.Pr." appears on the display).
5. Push [↑]/[↓] for adjusting to "ON" or "OFF".
6. Push [PROG] to confirm.

N.B. When Lo.Pr. is set to "ON", the display shows 104, 105, 107, 108, 109 and 111 and the adjusted values of the parameters. Afterwards "PROT" (Protected) is shown. Both protections can be adjusted at the same time, independent from each other.

**12.14 P114 Response Time from Push Buttons**

This option can only be used from software version 8.01. The response time from the push buttons can be adjusted from 0,0 till 5,0 seconds.

**12.15 P115 Service Menu**

Use only under order of manufacturer.

**12.16 P116 Service Menu**

Use only under order of manufacturer.

## 13 Programming the GOLD SERIES



When using HART® or a Hand Held Terminal (HHT), a minimum resistance of 250 ohms **must** be present in the loop of the 2-wire system. This is necessary for proper communication (see drawing below). A power supply of at least **17 Vdc** must be used.

### 13.1 Programming with the hand held terminal

The GOLD SERIES can be easily programmed with the Hand Held Terminal (HHT) from the "HART Foundation" or the HHT from "Rosemount" (type 275 or 375 Hart Communicator).

**Option 1:** HART® Handheld terminal connected across the transmitter.

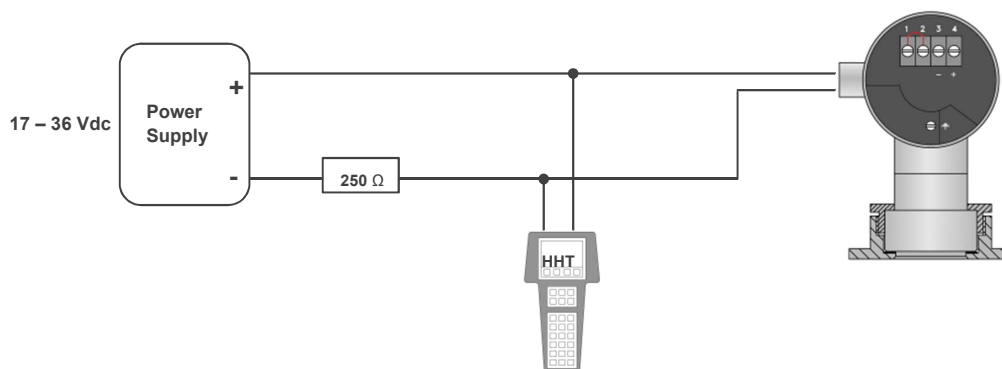

**Option 2:** HART® Handheld terminal connected across the loop resistor.

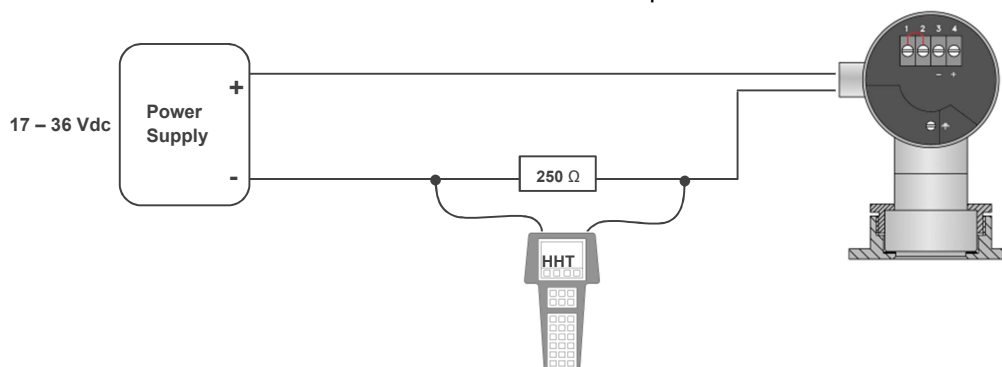

### 13.2 Programming with DTM

There is an instruction manual available which is a guide for installing and using the GOLD SERIES HART DTM. This DTM is developed to make configuration changes of GOLD SERIES HART transmitters easy. This DTM can be used with almost every FDT-container.

### 13.3 Programming with PDM

There is also a Device Description (DD) available for the GOLD SERIES HART. This DD can be used for configuring a GOLD SERIES HART transmitter using Simatic PDM.

## 14 Servicing

The device is maintenance-free. However, to ensure reliable operation and a long lifetime for the device, we recommend that it is checked regularly.

### 14.1 Safety

When undertaking servicing work on the device, the pressure lines must be depressurized, the electrical connections isolated from the mains supply, and the plant secured against being switched on again.

## **14.2 Check on function, and recalibration**

The check on function and recalibration is carried out at regular intervals, depending on the application. The precise testing cycles should be adjusted in line with the operating conditions and ambient conditions. In the event of various device components interacting, the operating instructions for all other devices should also be taken into account.

- Check on display.
- Check on function, in conjunction with downstream components.
- Check of pressurized connection pipes for seal condition.
- Check of electrical connections.

## **14.3 Cleaning and maintenance**

Cleaning is carried out using a non-aggressive cleaning agent, with the ventilation valve closed and respecting the protection category of the device.

# **15 Faults**

## **15.1 Safety**

Defective or faulty pressure transmitters put the operational safety and process safety of the plant at risk, and can lead to a risk or injury to persons, the environment or the plant.

## **15.2 Conduct in the event of faults**

All defective or faulty devices must be taken out of service. If a repair is required, the device must be sent directly to our Repairs Department. We request that all returns of devices are agreed with our Service Department.

## **15.3 Fault table**

Possible situations indicating a fault:

- No output signal
- Wrong output signal
- Cracked parts
- Indications that the measurement system seal is damaged (process media within the transducer)
- Damage to housing
- Humidity inside the transmitter (wrong sealing of termination)

In these instances, replacement of the pressure transmitter is always required.

## **15.4 Conduct following fault rectification**

See Section 8 Mounting and Installation.

# **16 Removal, disposal**

## **16.1 Safety**



Residues of measuring media in and on removed transmitters can constitute a risk to people, the environment and equipment. Adequate precautionary measures must be adopted. If necessary, the devices must be cleaned thoroughly (see advice in safety data sheets).

## **16.2 Removal**

- When undertaking servicing work on the device, the pressure lines must be depressurized, the electrical connections isolated from the mains supply, and the plant secured against being switched on again.
- Demount the transmitter using a suitable tool

## **16.3 Disposal**



Please help to protect the environment and dispose of or recycle the devices and components used in accordance with the applicable regulations.

## 17 Appendix

### 17.1 Data sheet for GOLD SERIES PG55 and CG55

Detailed data sheet is available from supplier's website (see 1.7 Manufacturer's address, customer services)

This Table refers to specific documents:

<b>Model</b>	<b>Description</b>	<b>Document</b>
PG55/CG55	Stainless steel pressure transmitter GOLD SERIES	G5.PG55-CG55-EN

## 17.2 Declaration of conformity model PG55 and CG55